



 **PILE  
CRITTER**

**DRILL BITS**



# TABLE OF CONTENTS



## ABOUT US

Introducing Pile Critter .....	5
--------------------------------	---

## PRODUCTS

Welded casing bits.....	7
Weld-on bits.....	8
Shank 13 bullet bits.....	9
Shank 14 bullet bits.....	9
Shank 18.7 bullet bits.....	10
Shank 19.4 bullet bits.....	11
Shank 25.5 bullet bits.....	13
Shank 38-30 bullet bits.....	14
Flat drill bits.....	20
Dragon drill bits.....	23
Casing drill bits.....	23
Tools.....	25

## CONTACTS

Team contact info.....	27
------------------------	----



## COMPANY

Founded in 2022, PileCrittter is a swiftly growing company in the European drilling market. Our team, though small, is rich in diversity and expertise, encompassing a range of roles from strategic leadership to market-specific business development. Fluent in multiple languages, our team is well-equipped to cater to various European markets. Together, our mission is rooted in delivering value through reliable, high-performance tools essential for construction and civil engineering.

At PileCrittter, we're driven by a relentless dedication to our customers, aiming to be the cornerstone of Europe's drilling industry. Our vision encompasses not just supplying tools but fostering growth and progress in every project we touch. We're focused on enhancing our services by developing rapid response teams, further decreasing dispatch times, and expanding our product catalogue. Join us in redefining drilling industry standards with solutions that speak of quality, efficiency, and innovation!

## EU HUB

Focusing on local stock within Europe, PileCrittter has significantly reduced delivery times and improved service dependability for our European clients. This strategic move underscores our dedication to addressing the unique requirements of the European market and strengthening our position in the region.

## BESPOKE SERVICE

We are eager to take on special requests, ensuring clients receive precisely what they need for their projects. We specialize in understanding unique requirements and leveraging an extensive product range to fulfill even the most specific demands. With a focus on customization and adaptability, our team is committed to turning special requests into reality, offering solutions that are not just satisfactory, but perfectly aligned with each client's unique business needs.



## **DRILL BITS**

**PileCrittter offers a diverse range of high-quality drill bits, each designed and manufactured to deliver exceptional performance in demanding conditions.**

## WELDED CASING BITS

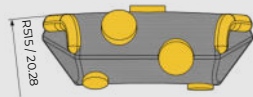
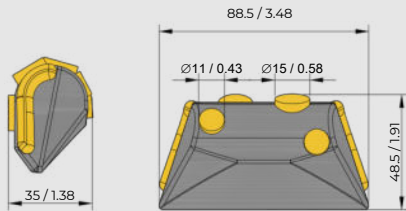

**MODEL: PC-BA01**

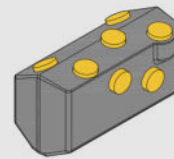
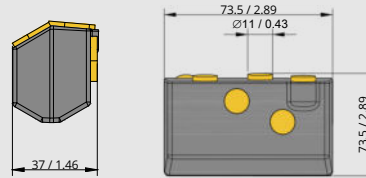

**MODEL: PC-BA04**

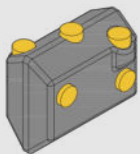
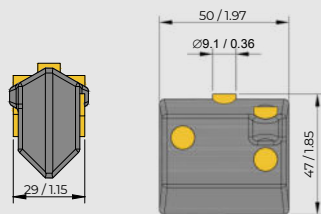

**MODEL: PC-BA09**

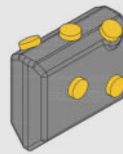
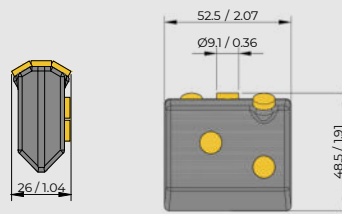

**MODEL: PC-BA10**

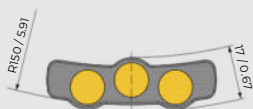
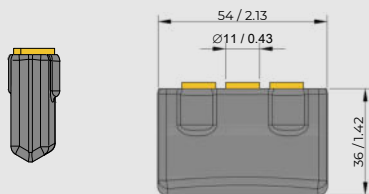

**MODEL: PC-BA012**

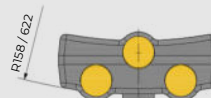
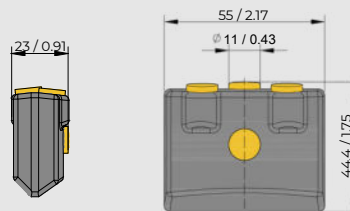

**MODEL: PC-BA13**

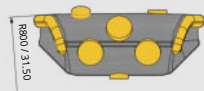
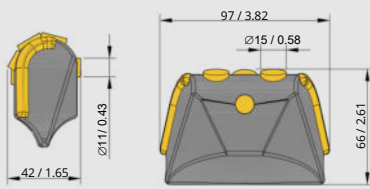

**MODEL: PC-BA24**

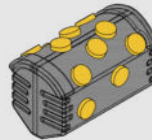
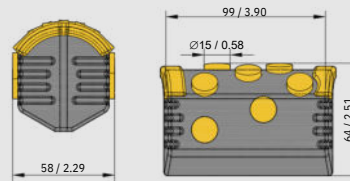

**MODEL: PC-BA28**

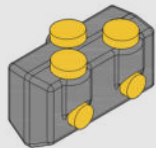
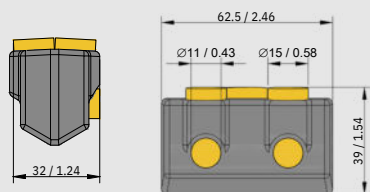

**MODEL: PC-BA32**

## WELD-ON BITS

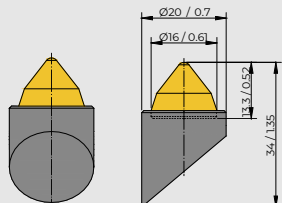

**MODEL: PC-BFZ158**

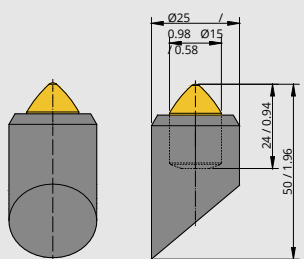

**MODEL: PC-BFZ207**



## SHANK 13 BULLET BITS

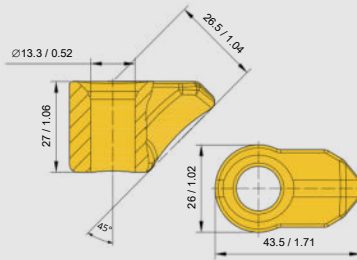

MODEL: PC-BHR47

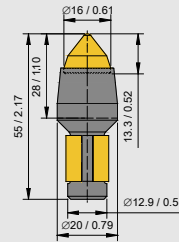

MODEL: PC-BHR62

## SHANK 14 BULLET BITS

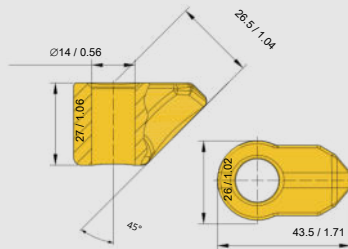

MODEL: PC-BHR109

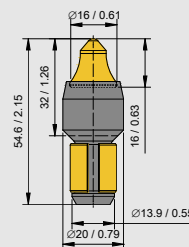

MODEL: PC-BM55

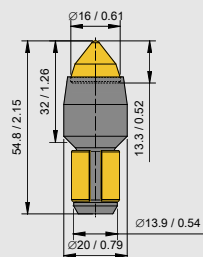

MODEL: PC-BM60

## SHANK 18.7 BULLET BITS

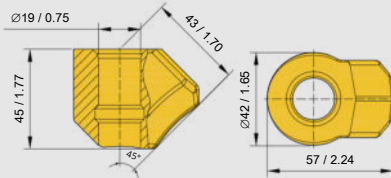

**MODEL: PC-BHR20**

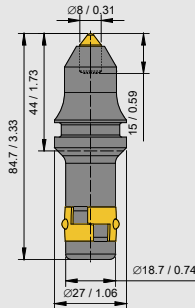

**MODEL: PC-BTR01**

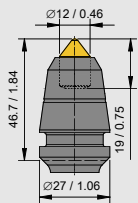

**MODEL: PC-BTR02**

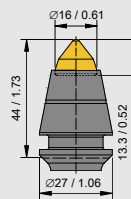

**MODEL: PC-BTR03**

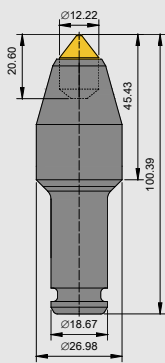

**MODEL: PC-C21RHD**

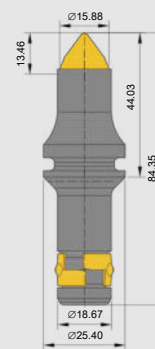

**MODEL: PC-C23**

## SHANK 19.4 BULLET BITS

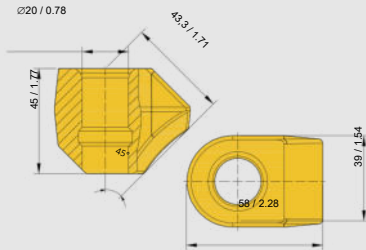

**MODEL: PC-BHR07**

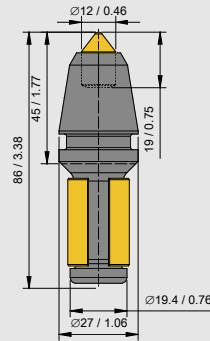

**MODEL: PC-BSH05**

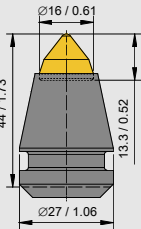

**MODEL: PC-BSH09**

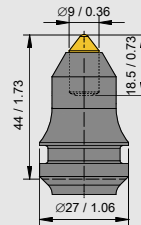

**MODEL: PC-BSK15**

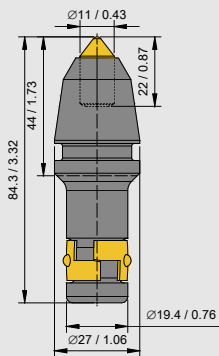

**MODEL: PC-BSK16**

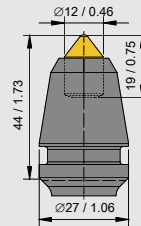

**MODEL: PC-BSK17**

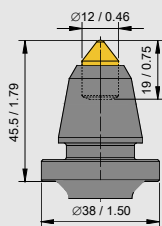

**MODEL: PC-BSK21**

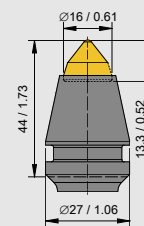

**MODEL: PC-BSK23**



## SHANK 25.5 BULLET BITS

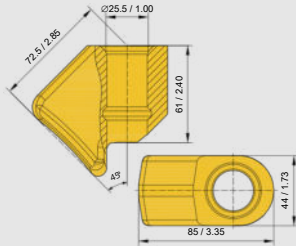

**MODEL: PC-BHR31**

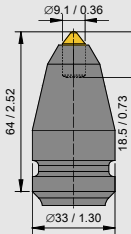

**MODEL: PC-BTK01**

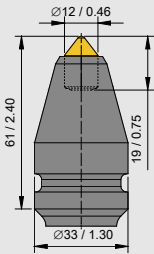

**MODEL: PC-BTK03**

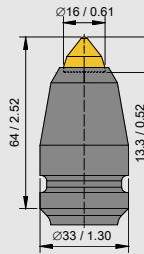

**MODEL: PC-BTK16**

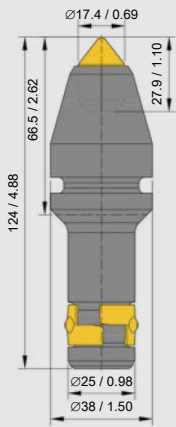

**MODEL: PC-BTK70**

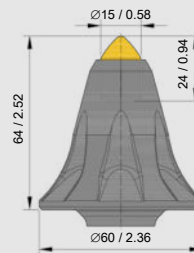

**MODEL: PC-BTK81**

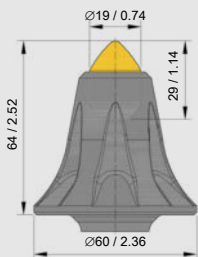

**MODEL: PC-BTK89**

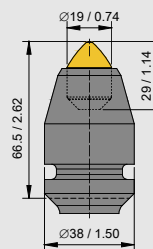

**MODEL: PC-BTK162**

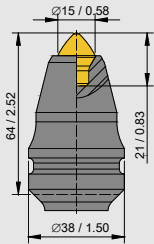

**MODEL: PC-BTK164**

## SHANK 38-30 BULLET BITS

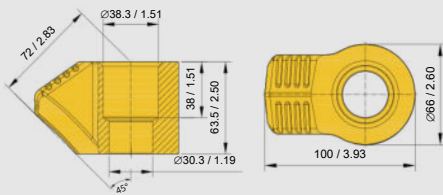

**MODEL: PC-BHR38**

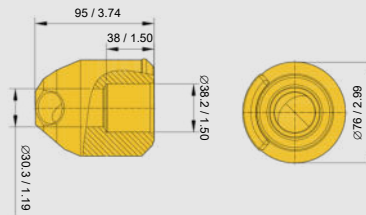

**MODEL: PC-BHR163**

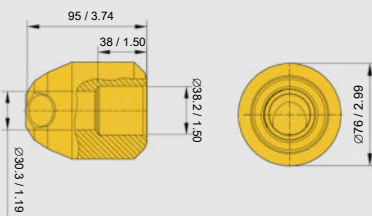

**MODEL: PC-BHR216**

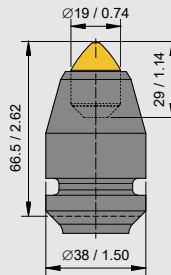

**MODEL: PC-55-12K22**

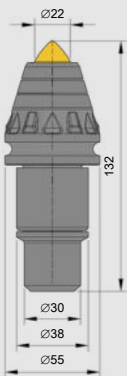

**MODEL: PC-55-22**

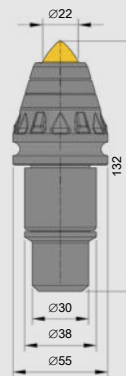

**MODEL: PC-55-22S**

# DRILL BITS

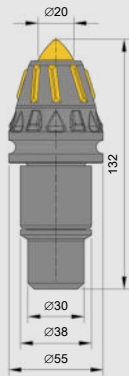

**MODEL: PC-55-9T20**

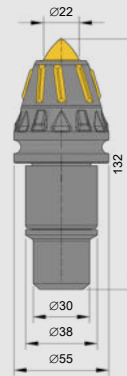

**MODEL: PC-55-9T22**



**MODEL: PC-60-10T24**

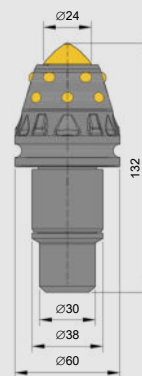

**MODEL: PC-60-10K24**

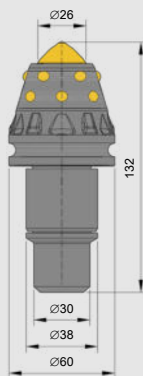

**MODEL: PC-60-10K26**

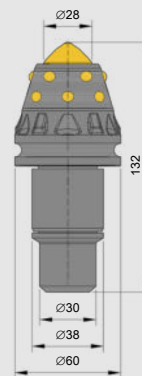

**MODEL: PC-60-10K28**

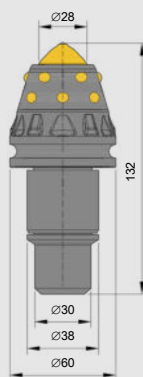

**MODEL: PC-60-12K30**



**MODEL: PC-60-24**

# DRILL BITS

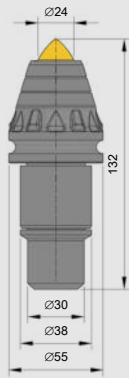

**MODEL: PC-60-24S**

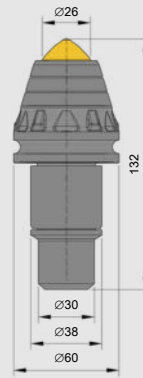

**MODEL: PC-60-26**

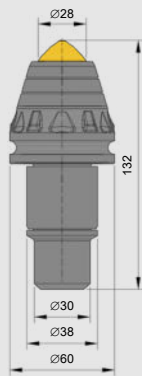

**MODEL: PC-60-28**

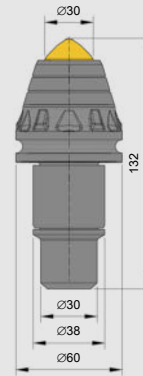

**MODEL: PC-60-30**

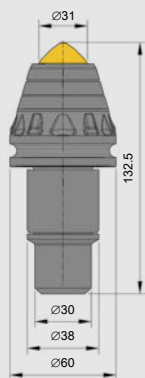

**MODEL: PC-60-31**

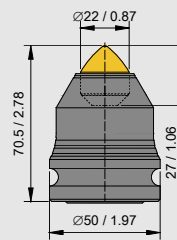

**MODEL: PC-BKH105**

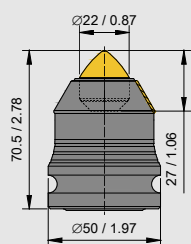

**MODEL: PC-BKH105B**

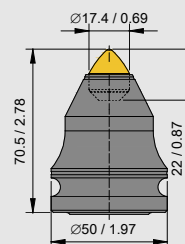

**MODEL: PC-BKH110**



# DRILL BITS

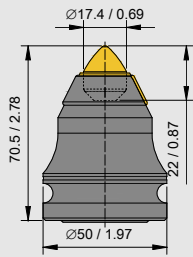

**MODEL: PC-BKH110P**

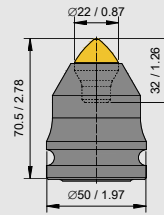

**MODEL: PC-BKH130**

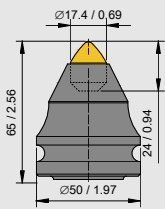

**MODEL: PC-BKH140**

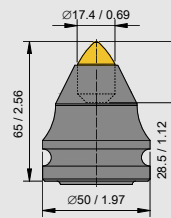

**MODEL: PC-BKH28**

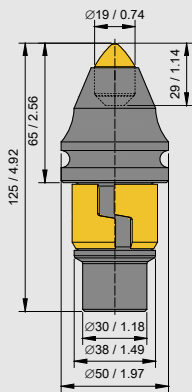

**MODEL: PC-BKH40**

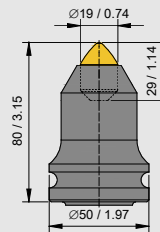

**MODEL: PC-BKH41**

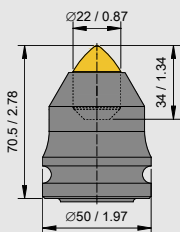

**MODEL: PC-BKH47**

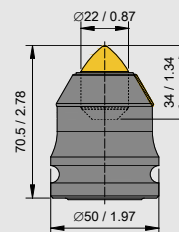

**MODEL: PC-BKH47P**

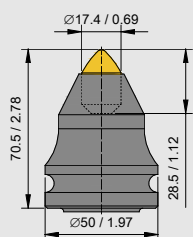

**MODEL: PC-BKH80**

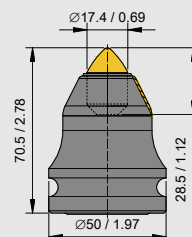

**MODEL: PC-BKH80P**

# DRILL BITS

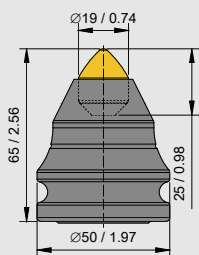

**MODEL: PC-BKH83**

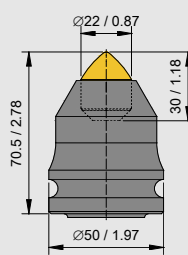

**MODEL: PC-BKH85**

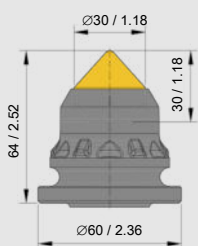

**MODEL: PC-BKH92**

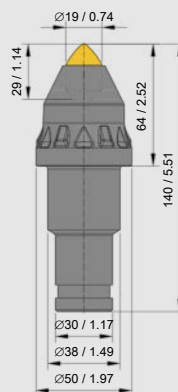

**MODEL: PC-BKS154**

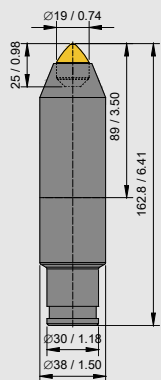

**MODEL: PC-BKS186**

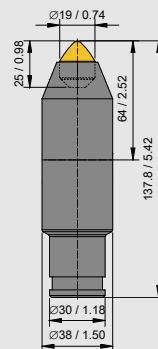

**MODEL: PC-BKS187**

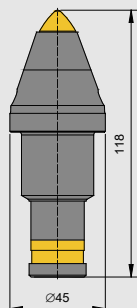

**MODEL: PC-RSM-F**



## FLAT DRILL BITS

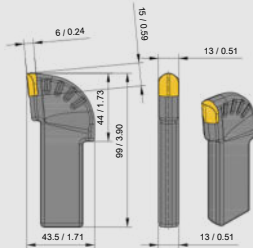

MODEL: PC-BF64

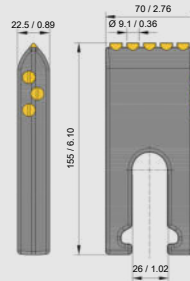

MODEL: PC-BFZ02

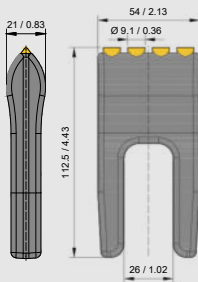

MODEL: PC-BFZ05N

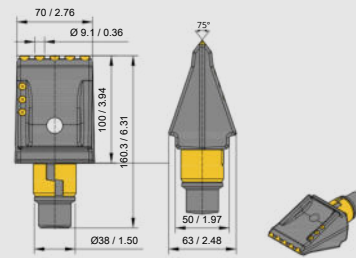

MODEL: PC-BFZ162

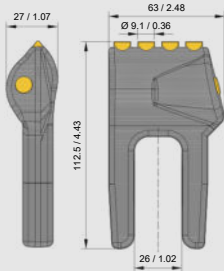

MODEL: PC-BFZ198N

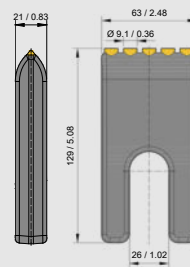

MODEL: PC-BFZ200N

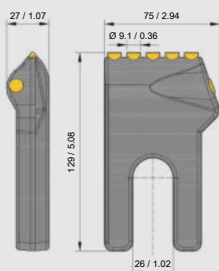

MODEL: PC-BFZ218

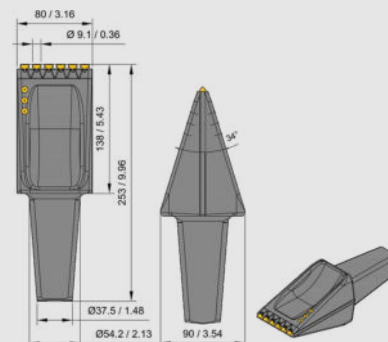

MODEL: PC-BFZ317

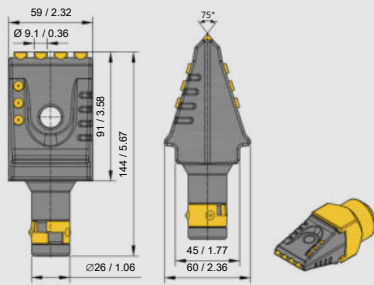

**MODEL: PC-BFZ324**

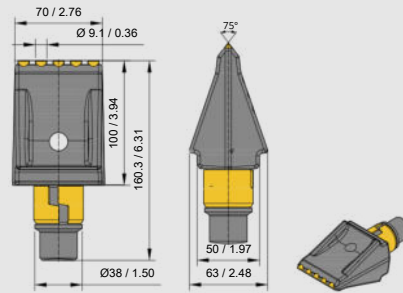

**MODEL: PC-BFZ339**

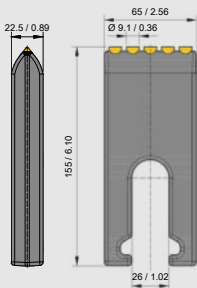

**MODEL: PC-BFZ65HM**

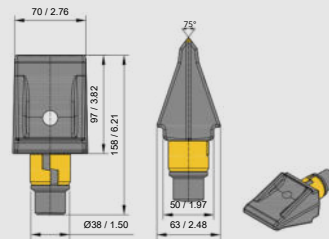

**MODEL: PC-BFZ69**

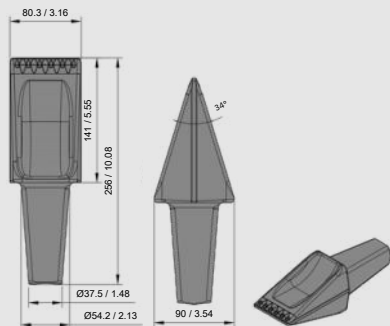

**MODEL: PC-BFZ79**

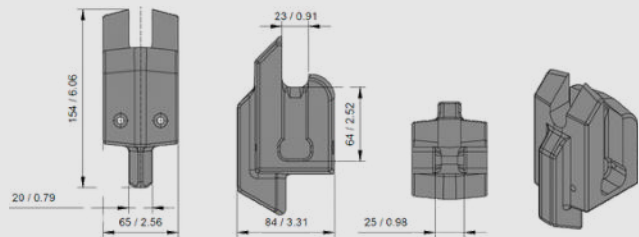

**MODEL: PC-BHF02**



**MODEL: PC-BHR112**

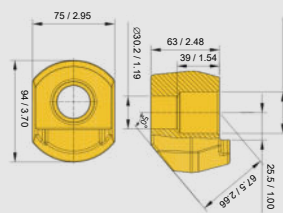

**MODEL: PC-BHR39**

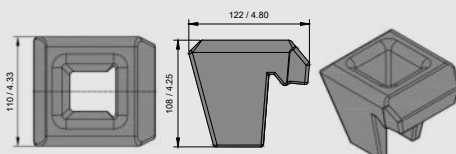

**MODEL: PC-BHR73**

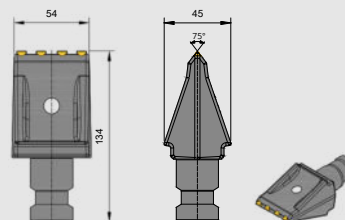

**MODEL: PC-FZ54**

# DRILL BITS

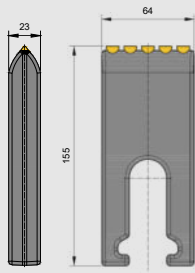

**MODEL: PC-FZ64**

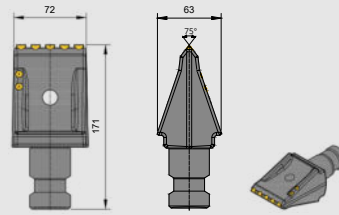

**MODEL: PC-FZ72**

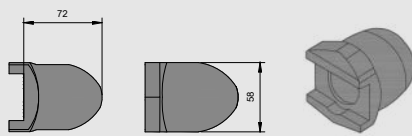

**MODEL: PC-FZH54**

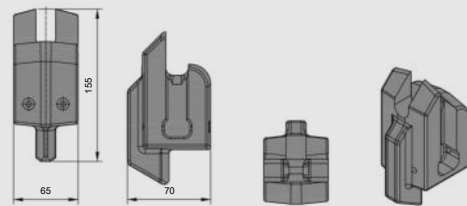

**MODEL: PC-FZH64**

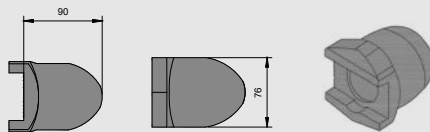

**MODEL: PC-FZH72**

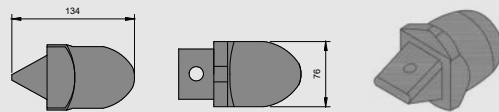

**MODEL: PC-FZHI54**

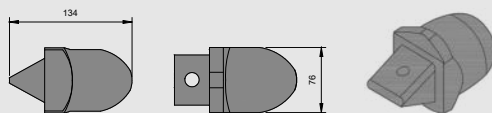

**MODEL: PC-FZHI72**

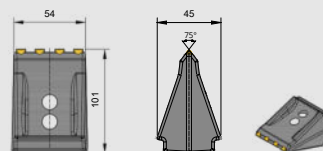

**MODEL: PC-FZI54**

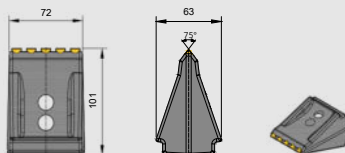

**MODEL: PC-FZI72**

## DRAGON DRILL BITS

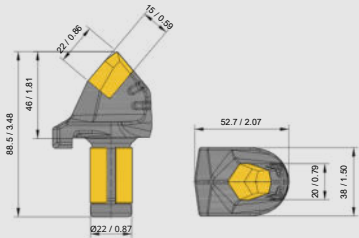

**MODEL: PC-BFR07**

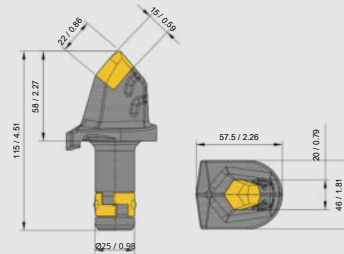

**MODEL: PC-BFR08**

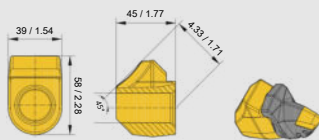

**MODEL: PC-BHR133**

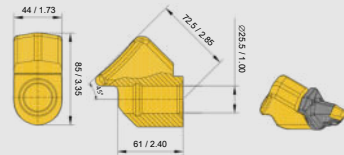

**MODEL: PC-BHR184**

## CASING DRILL BITS

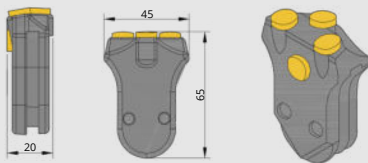

**MODEL: PC-WS20**



**MODEL: PC-WS39**

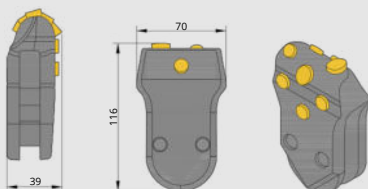

**MODEL: PC-WS39-R**



**MODEL: PC-WS46**

# DRILL BITS



**MODEL: PC-WS52**

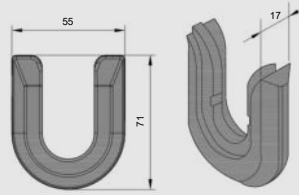

**MODEL: PC-WSH20**

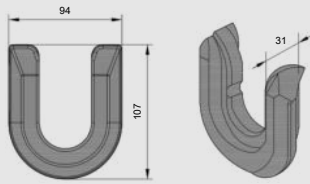

**MODEL: PC-WSH39-52**

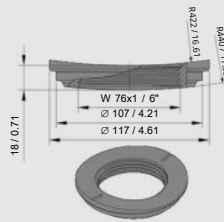

**MODEL: PC-BRV02**

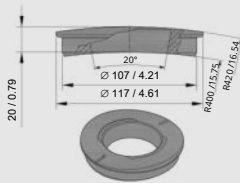

**MODEL: PC-BRV03**

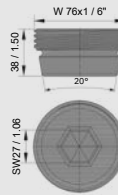

**MODEL: PC-BRV08**

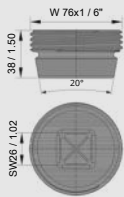

**MODEL: PC-BRV10**

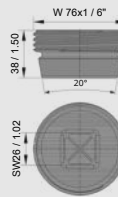

**MODEL: PC-BRV23**

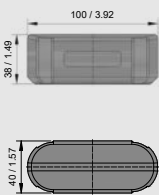

**MODEL: PC-BRV32**

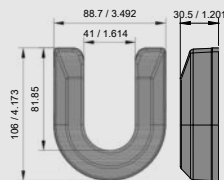

**MODEL: PC-BRV49**



## TOOLS

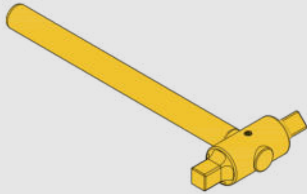

**MODEL:** PC-BRV35



**SIZES:** 50/55/60



## Connect with us for a personalised service.

Didn't find what you were looking for in our catalog? Reach out to connect with a dedicated account manager, who can introduce you to our wider selection of drill bits, ensuring you find the perfect match for your project needs.

Tel: +371 200 20 375

E-mail: [info@pilecritter.com](mailto:info@pilecritter.com)

[www.pilecritter.com](http://www.pilecritter.com)



 **PILE**  
**CRITTER**